

# Data Sheet



Article number: 021816011160

Description: Clamp with bracket and rubber  
SPGU 6011. 160/30 SK

## Measures

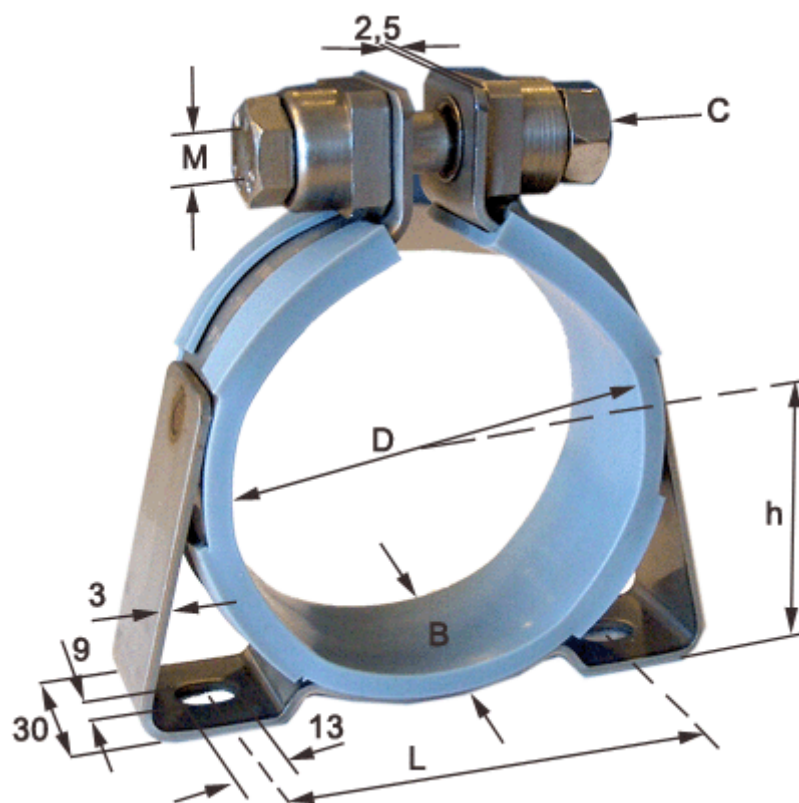

C (screw type) = SK hexagon screw

Diameter D = 160

h = 89

L = 148

Width B = 30